

Mandatory Disclosure

	Mandatory Disclosure updated on:- 10/08/2020
1	AICTE File No.:- WESTERN/2020/1-7014492378
	Date & Period of last approval:- Western/1-7014492378/2020/EOA Date: 30-Apr-2020
2	Name of the Institution:- Sanghavi College of Engineering
	Address of the Institution:-At- Varvandi,Post-Dhakambe,Via MERI Colony, Mhasrul, Nashik-422 004
	City & Pin Code:- Nashik-422 004
	State / UT:- Maharashtra
	Latitude:-20.067783, Longitude:- 73.838704.
	Phone number with STD code:- (02557)259091 / (02557) 204612
	FAX number with STD code:-(02557)259091
	Office hours at the Institution:-09.30am to 05:30 pm
	Academic hours at the Institution:- 09.30am to 05:30 pm
	Email:- principal.scenashik@shreemahavir.org
	Website:-www.scenashik.org
	Nearest Railway Station(dist in Km):-Nashik road-Nashik.[Distance in 20Kms.]
	Nearest Airport(dist in Km):- Ozar mig-Nashik [Distance in 15Kms.]
3	Type on Institution Private-Self Financed
	Category(1) of the Institution
	Category(2) of the Institution Co-Education

4 Name of the organization running the Institution:- Shree Mahavir Education Society

Type of the organization:- Trust

Address of the organization:- D-24, MIDC, Satpur, Nashik – 422 007

Registered with:- Deputy Charity Commissioner, Nashik Region, Nashik. Maharashtra

Registration date:- 20/02/1997

Website of the organization:- www.shreemahavir.org

Name of the affiliating University:- Savitribai Phule Pune University, Pune

Address: - Ganeshkhind, Pune-411007

Website:-www.unipune.ac.in

Latest affiliation period: For
Academic Year 2020-21 Letter
No.CA/531 Dated on
05/08/2020

6 Name of Principal / Director: - Prof. N. V. Palde

In-charge Principal

Phone number with STD code:-02557-259091

FAX number with STD code :-(02557)-259091

Email:- principal.scenashik@shreemahavir.org

Highest Degree: - M.E. MECHANICAL ENGG.

Field of specialization:-Mechanical Engineering.

GOVERNING BODY MEMBER LIST
(GB)

SI No	Name	Designation
1	Mr. H. L. Sanghavi (Industrialist)	Chairman
2	Mr. R. H. Sanghavi (Industrialist)	Member
3	Mr. Atul Mundada (Advisor)	Member
4	Mr. S. S. Manerikar (Advisor)	Member
5	Mr. Bhavesh Lakhani (Industrialist)	Member
6	Mr. Ashok Kothade (Advocate)	Member
7	Mr.S.V.Sagare (Principal – SMES Poly College)	Member
8	Dr.A.M.Deshpande (Principal – SMES Pharmacy College)	Member
9	Prof. N.V.Palde (Principal,Sanghavi College of Engg.)	Member
10	(Ex-Officer of Samaj Kalyan – Govt of MH)	Member
11	Regional Officer (Nominee of AICTE WRO,Mumbai)	Member
12	(Nominee of Affiliating University)	Member
13	(Nominee of DTE RO)	Member

Frequency of meetings & date of last - Yearly –

Frequency of meetings: - Yearly, Date of last meetings:- 07/01/2020

Academic Advisory Body:-The college has constituted the Local Management Committee which Comprises of following members and governs the process of Academic Advise.

SI No	Name of the Academic Advisory members	Appointed for the Position of
1	Mr.H.L.Sanghavi (Chairman - SMES)	Chairman
2	Mr.Rahul Sanghavi (Secretary – SMES)	Secretary
3	Dr. P. A. Zawar (HOD Applied Science)	Member (HOD)
4	Mr. T. H. Boraste (Asst. Professor , Civil)	Member (Teaching)
5	Mr. B. S. Shirole (Asst. Professor , Computer)	Member (Teaching)
6	Mrs. P. P. Bagul (Asst. Professor & HOD , Electrical)	Member (Teaching)
7	Mr. J. D. Amrutkar (Admin)	Member (Non-Teaching)
8	Mr. S. V. Lokhande (Asst. Professor, Mechanical)	Member (Coordinator IQAC)
9	Mr. Atul Mundada (Industrialist)	Member (Industrialist)
10	Mr. Anand Zawar (Chartered Accountant)	Member
11	Mr. S. V. Sagare (Principal , Mahavir Polytechnic)	Member
12	Mr. N. V. Palde (In charge Principal)	Member Secretary

Frequency of meetings & date of last meeting: - (Six monthly) 07/01/2020

**SIMES's Sanghavi College of Engineering
Nashik
ORGANISATION STRUCTURE**

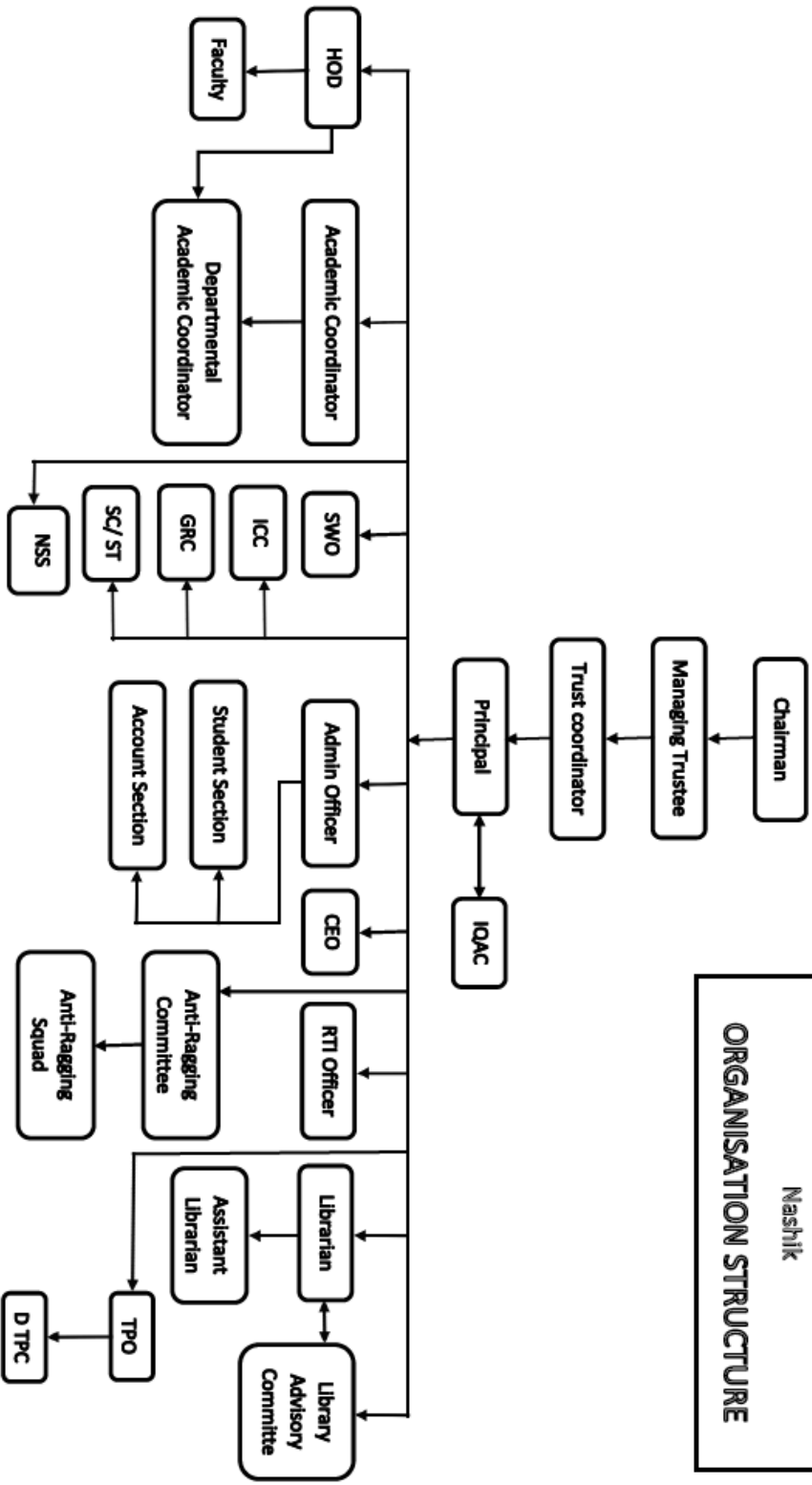

Abbreviation:

- | | |
|--|-------------------------------------|
| IQAC: Internal Quality Assurance Cell | HOD: Head of Department |
| SWO: Student Welfare Officer | ICC: Internal Complaint Committee |
| GRC: Grievance Redressal Cell | CEO: College Examination Officer |
| RTI: Right to Information | TPO: Training and Placement Officer |
| D TPC: Departmental Training and Placement Coordinator | NSS: National Service Scheme |

10	Student feedback mechanism on Institutional Governance/faculty performance:-	In each semester students feedback is obtained in the prescribed format. The same is analysed and based on the data action is initiated.
----	--	--

11	Grievance redressal mechanism for faculty, staff and students:-	There is grievance redressal cell in the college and the cell is working independently. Any one either student or faculty may approach to the cell if their grievance is not taken care by the Management.
----	---	--

Faculty/Staff Grievances committee members		
1	Ms. K. A. Pekhale	Member
2	Mrs. P. P. Bagul	Member
3	Mr. S. V. Lokhande	Member
4	Mr. T. H. Boraste	Member
5	Mr. L. C. Jadhav	Member
6	Mr. S. B. Pachpande	Member
Students Grievances committee members		
1	Mr. P. A. Renuke	Member
2	Mr. B. S. Shirole	Member
3	Mr. N. N. Shewale	Member
4	Ms. K. A. Pekhale	Member
5	Mrs. U. A. Khairnar	Member

Current Academic Year 2020-21

Name of the Department	Civil	Computer	Electrical	E & TC	Mechanical
Course	Engineering	Engineering	Engineering	Engineering	Engineering
Level	Under Graduate	Under Graduate	Under Graduate	Under Graduate	Under Graduate
1st year of approval by the Council	2020-21	2020-21	2020-21	2020-21	2020-21
Year wise sanctioned intake	30	60	30	00	60
Year wise actual admissions					
FE	20	34	07	00	07
SE	32	33	32	00	62
TE	46	35	32	01	52
BE	81	29	43	13	59
Cut off marks-General Quata					
% Students passed with distinction					
% Students passed with First Class					
Students Placed					
Average Pay package, Rs./Year					
Students opted for Higher Studies					

Academic Year 2019-20

Name of the Department	Civil	Computer	Electrical	E & TC	Mechanical
Course	Engineering	Engineering	Engineering	Engineering	Engineering
Level	Under Graduate	Under Graduate	Under Graduate	Under Graduate	Under Graduate
1st year of approval by the Council	2019-20	2019-20	2019-20	2019-20	2019-20
Year wise sanctioned intake	27	27	27	00	54
Year wise actual admissions					
FE	06	15	01	0	3
SE	34	35	29	0	37
TE	49	19	35	3	46
BE	74	33	67	23	89
Cut off marks-General Quota					
% Students passed with distinction					
% Students passed with First Class					
Students Placed					
Average Pay package, Rs./Year					
Students opted for Higher Studies					

Academic Year 2018-19

Name of the Department	Civil	Computer	Electrical	E & TC	Mechanical
Course	Engineering	Engineering	Engineering	Engineering	Engineering
Level	Under Graduate	Under Graduate	Under Graduate	Under Graduate	Under Graduate
1 st year of approval by the Council	2018-19	2018-19	2018-19	2018-19	2018-19
Year wise sanctioned intake	27	27	27	27	54
Year wise actual admissions					
FE	02	04	04	00	01
SE	58	18	26	00	53
TE	66	33	64	17	81
BE	60	32	39	18	66
Cut off marks-General Quota					
% Students passed with distinction					
% Students passed with First Class					
Students Placed					
Average Pay package, Rs./Year					
Students opted for Higher Studies					

Accreditation Status of the course	Not eligible yet
Doctoral Courses	No
Foreign Collaborations, if any	No
Professional Society Memberships:-	No
Professional activities:-	Technical Quiz, Paper Presentations, MahaCoEsta etc. are organised
Consultancy activities:-	All branches are extending their services to Industries
Grants fetched:-	No

Departmental Achievements:- N.A.

Distinguished Alumni:-N.A.(College is established in the academic year 2012-13)

	Name of Teaching Staff:- Palde Navnath Vasant			
	Designation: - Asst. Professor			
	Department: - Mechanical Engineering			
	Date of Joining the Institution:-			
	Qualifications with Class/Grade	UG: - B.E. (First class)	PG: - M.E. (First Class)	
	Total Experience in Years: -	Teaching: - 8	Industry: - 2	
	Research:-			
	Papers Published :- 02	National:-	International:-02	
	Papers Presented in Conferences :-	National: -	International:-	
	PhD's Guide? Give field & University	Field:-	University:-	
	PhDs / Projects Guided	PhDs:-	Projects at Masters Level:-	
	Books Published /IPRs/ Patents:-			
	Professional Memberships:-			
	Consultancy Activities:-			
	Awards:-			
	Grants fetched:-			
	Interaction with Professional Institutions:-			

	Name of Teaching Staff:- Dr. Priyanka Anand Zawar	
	Designation: - H.O.D.	
	Department: -Engg. Chemistry	
	Date of Joining the Institution:- 1st August 2012	
	Qualifications with Class/Grade: Ph.D (Organic Chemistry) UG: - PG: -	
	Total Experience in Years: - Teaching: - 5 Industry: - 0 Research:-3	
	Papers Published :- National:- 4 International:-26	
	Papers Presented in Conferences :- National: - 1 International:- 1	
	PhD's Guide? Give field & University Field:- University:-	
	PhDs / Projects Guided PhDs:- Projects at Masters Level:-	
	Books Published /IPRs/ Patents:-	
	Professional Memberships:-	
	Consultancy Activities:-	
	<ul style="list-style-type: none"> • Awards:- Chinese Chemical Letters, Volume 22, Issue 5: 2011 papers has recently been as selected as High Cited Article in 2013 • Editor-In-Chief in World Research Journal of Chemistry • Advisory Board in International Journal of Chemical Research • Tetrahedron Letters, Volume 51, Issue 23: 2010 papers has recently been recognized in the "Top-25 most cited articles" as published in Tetrahedron Letters (2010-2011) 	
	Grants fetched:-	
	Interaction with Professional Institutions:-	

	Name of Teaching Staff:- SHEWALE ANURADHA SHRAVAN	
	Designation: -ASST.PROFFESOR	
	Department: - APPLIED SCIENCE DEPT.(MATHEMATICS)	
	Date of Joining the Institution:- 12/07/2016	
	Qualifications with Class/Grade UG: - B.Sc (MATHEMATISC) 67% PG: - M.Sc (MATHEMATICS) 62%	
	Total Experience in Years: -06Teaching:- 06Industry: - Research:-	
	Papers Published :- National:-International:-	
	Papers Presented in Conferences :- National: - International:-	
	PhD's Guide? Give field & University Field:- University:-	
	PhDs / Projects Guided PhDs:-	
	Books Published /IPRs/ Patents:-	
	Professional Memberships:-	
	Consultancy Activities:-	
	Awards:-	
	Grants fetched:-	
	Interaction with Professional Institutions:-	

	Name of Teaching Staff:- Prof. Shewale Nilesh Nivrutti.	
	Designation: - Assistant Professor	
	Department: - Civil Engineering	
	Date of Joining the Institution:- 2/6/2014	
	Qualifications with Class/Grade UG: -First Class PG: - Higher Second Class	
	Total Experience in Years: - Teaching: - 11Yrs Industry: - 01 YRS Research:-	
	Papers Published :- National:- 02 International:-	
	Papers Presented in Conferences :- National: - International:-	
	PhD's Guide? Give field & University Field:- University:-	
	PhDs / Projects Guided PhDs:- Projects at Masters Level:-	
	Books Published /IPRs/ Patents:-	
	Professional Memberships:-	
	Consultancy Activities:-	
	Awards:-	
	Grants fetched:-	
	Interaction with Professional Institutions:-	

	Name of Teaching Staff:- Prof. Jagtap Ravindra Trambak.	
	Designation: - Assistant Professor	
	Department: - Civil Engineering	
	Date of Joining the Institution:- 1/6/2014	
	Qualifications with Class/Grade UG: -First Class PG: - First Class	
	Total Experience in Years: - Teaching: - 11Yrs Industry: - 00 YRS Research:-	
	Papers Published :- National:- 01 International:-	
	Papers Presented in Conferences :- National: - International:-01	
	PhD's Guide? Give field & University Field:- University:-	
	PhDs / Projects Guided PhDs:- Projects at Masters Level:-	
	Books Published /IPRs/ Patents:-	
	Professional Memberships:-	
	Consultancy Activities:-	
	Awards:-	
	Grants fetched:-	
	Interaction with Professional Institutions:-	

	Name of Teaching Staff:- Prof. Kakani Mansi Jagganath	
	Designation: - Assistant Professor	
	Department: - Civil Engineering	
	Date of Joining the Institution:- 15/9/2020	
	Qualifications with Class/Grade UG: -First Class PG: - First Class	
	Total Experience in Years: - Teaching: - 5Yrs Industry: - 00 YRS Research:-	
	Papers Published :- National:- 01 International:-01	
	Papers Presented in Conferences :- National: - 00 International:-01	
	PhD's Guide? Give field & University Field:- University:-	
	PhDs / Projects Guided PhDs:- Projects at Masters Level:-	
	Books Published /IPRs/ Patents:-	
	Professional Memberships:-	
	Consultancy Activities	
	Awards:-	
	Grants fetched:-	
	Interaction with Professional Institutions:-	



	Name of Teaching Staff:- Prof. Mapari Pallavi Pandit	
	Designation: - Assistant Professor	
	Department: - Civil Engineering	
	Date of Joining the Institution:- 15/9/2020	
	Qualifications with Class/Grade UG: -First Class PG: - First Class	
	Total Experience in Years: - Teaching: - 5Yrs Industry: - 00 YRS Research:-	
	Papers Published :- National:- 01 International:-00	
	Papers Presented in Conferences :- National: - 00 International:-02	
	PhD's Guide? Give field & University Field:- University:-	
	PhDs / Projects Guided PhDs:- Projects at Masters Level:-	
	Books Published /IPRs/ Patents:-	
	Professional Memberships:-	
	Consultancy Activities:-	
	Awards:-	
	Grants fetched:-	
	Interaction with Professional Institutions:-	

	Name of Teaching Staff:- Prof. Boraste Toshnil Haribhau	
	Designation: - Assistant Professor	
	Department: - Civil Engineering	
	Date of Joining the Institution:- 28/12/2015	
	Qualifications with Class/Grade UG: -First Class PG: - First Class	
	Total Experience in Years: - Teaching: - 6 Yrs Industry: - 00 YRS Research:-	
	Papers Published :- National:- 01 International:-02	
	Papers Presented in Conferences :- National: - 01 International:-01	
	PhD's Guide? Give field & University Field:- University:-	
	PhDs / Projects Guided PhDs:- Projects at Masters Level:-	
	Books Published /IPRs/ Patents:-	
	Professional Memberships:-	
	Consultancy Activities:-	
	Awards:-	
	Grants fetched:-	
	Interaction with Professional Institutions:-	

	Name of Teaching Staff:- Prof. Kapure Raviraj Sharad	
	Designation: - Assistant Professor	
	Department: - Civil Engineering	
	Date of Joining the Institution:- 05/10/2020	
	Qualifications with Class/Grade UG: -First Class PG: - Pursuing	
	Total Experience in Years: - Teaching: - 1.5Yrs Industry: - 0.6 YRS Research:-	
	Papers Published :- National:- 01 International:-00	
	Papers Presented in Conferences :- National: - 00 International:-00	
	PhD's Guide? Give field & University Field:- University:-	
	PhDs / Projects Guided PhDs:- Projects at Masters Level:-	
	Books Published /IPRs/ Patents:-	
	Professional Memberships:-	
	Consultancy Activities:-	
	Awards:-	
	Grants fetched:-	
	Interaction with Professional Institutions:-	

	Name of Teaching Staff:- Kalekar Deelip Balkrushna	
	Designation: - Assistant Professor	
	Department: - Civil Engineering	
	Date of Joining the Institution:-	
	Qualifications with Class/Grade UG: - 1st class with Distinction PG: - 1st Class	
	Total Experience in Years: - 5.6 Teaching: -5 Yrs. Industry: - 6Month Research:-	
	Papers Published :- 09 National:- International:- 09	
	Papers Presented in Conferences :- National: - International:-04	
	PhD's Guide? Give field & University Field:- University:-	
	PhDs / Projects Guided PhDs:- Projects at Masters Level:-	
	Books Published /IPRs/ Patents:- 03	
	Professional Memberships:- International Association of Online Engineering	
	Consultancy Activities:-Nil	
	Awards:-	
	Grants fetched:-	
	Interaction with Professional Institutions:-	

	Name of Teaching Staff:- PUSPENDU BISWAS	
	Designation: - HEAD OF DEPARTMENT	
	Department: - COMPUTER ENGINEERING	
	Date of Joining the Institution:- 1ST AUGUST, 2012	
	Qualifications with Class/Grade UG: - FIRST DIVISION, 2005; PG: - FIRST CLASS, 2007; PhD:- Pursuing	
	Total Experience in Years: - 13 Teaching: - 12 Industry: - 1 Research:-	
	Papers Published :- 8 National:-8 International:-	
	Papers Presented in Conferences :- National: - International:-	
	PhD's Guide? Give field & University Field:- University:-	
	PhDs / Projects Guided PhDs:- Projects at Masters Level:-	
	Books Published /IPRs/ Patents:- Data Structure and Problem Solving (success publication)	
	Professional Memberships:-	
	Consultancy Activities:-	
	Awards:- GATE 2004, 2005, 2014, 2015, 2019	
	Grants fetched:-	
	Interaction with Professional Institutions:-	



	Name of Teaching Staff:- Bajirao Subhash Shirole	
	Designation: - Assistant Professor	
		
	Department: - Computer Engineering	
	Date of Joining the Institution:- 1/2/2013	
	Qualifications with Class/Grade UG: - BE (I.T) (First Class) PG: - M. Tech (First Class) Ph.D. :- Pursuing	
	Total Experience in Years: - 11 Teaching:- 11 Industry: - Research:-	
	Papers Published :- 10 National:- 01 International:- 09	
	Papers Presented in Conferences :- National: - International :- 01	
	PhD's Guide? Give field & University Field:- University:-	
	PhDs / Projects Guided PhDs:-	
	Books Published /IPRs/ Patents:-	
	Professional Memberships:- ISTE Lifetime Membership	
	Consultancy Activities:-	
	Awards:-	
	Grants fetched:-	
	Interaction with Professional Institutions:-	

	Name of Teaching Staff:- Pekhale Kanchan Anil	
	Designation: - Assistant Professor	
	Department: - Computer Engineering	
	Date of Joining the Institution:- 19/12/2016	
	Qualifications with Class/Grade UG: - B.E. Distinction PG: - M.E.Distinction	
	Total Experience in Years: - 4.1 Teaching: - 4.1 Industry: - Research:-	
	Papers Published :- 5 National:- International:- 5	
	Papers Presented in Conferences :- 1 National: - 1 International:-	
	PhD's Guide? Give field & University Field:- - University:- -	
	PhDs / Projects Guided PhDs:- - Projects at Masters Level:- -	
	Books Published /IPRs/ Patents:-	
	Professional Memberships:-	
	Consultancy Activities:-	
	Awards:-	
	Grants fetched:-	
	Interaction with Professional Institutions:- -	

	Name of Teaching Staff:- Prof. N.S. Ahire	
	Designation: - Asst. Professor	
	Department: - Computer Engineering	
	Date of Joining the Institution:- 02nd Jan. 2019	
	Qualifications with Class/Grade UG: - BE(Computer) First Class PG: - ME (Computer) First Class	
	Total Experience in Years: - Teaching: - 2 years Industry: - 1.5 years Research:-	
	Papers Published :- 4 National:- 2 International:- 0	
	Papers Presented in Conferences :- National: - 1 International:- 0	
	PhD's Guide? Give field & University Field:- University:-	
	PhDs / Projects Guided PhDs:- Projects at Masters Level:-	
	Books Published /IPRs/ Patents:-	
	Professional Memberships:-	
	Consultancy Activities:-	
	Awards:-	
	Grants fetched:-	
	Interaction with Professional Institutions:-	

	Name of Teaching Staff:- Mr. Sandeep Ramesh Jadhav	
	Designation: - Assistant Professor	
	Department: - Computer Engineering	
	Date of Joining the Institution:- 08/07/2019	
	Qualifications with Class/Grade UG: - BE Computer (Distinction) PG: - ME Computer (Distinction)	
	Total Experience in Years: - 03 Teaching: - 3 Yr Industry: - Research:-	
	Papers Published :- 03 National:- 01 International:- 02	
	Papers Presented in Conferences :- 1 National: - 1 International:-	
	PhD's Guide? Give field & University Field:- University:-	
	PhDs / Projects Guided PhDs:- Projects at Masters Level:-	
	Books Published /IPRs/ Patents:-	
	Professional Memberships:-	
	Consultancy Activities:-	
	Awards:-	
	Grants fetched:-	
	Interaction with Professional Institutions:-	

	Name of Teaching Staff:- Swati Satish Hinge	
	Designation: - Assistant Professor	
	Department: - Computer Engineering	
	Date of Joining the Institution:- 12/10/2020	
	Qualifications with Class/Grade UG: - BE (I.T.) Distinction PG: - ME (Computer) Distinction.	
	Total Experience in Years: -04 Teaching: - 04 Industry: - - Research:- -	
	Papers Published :-04 National:- 01 International:- 03	
	Papers Presented in Conferences :- 01 National: - - International:-01	
	PhD's Guide? Give field & University Field:- University:-	
	PhDs / Projects Guided PhDs:- Projects at Masters Level:-	
	Books Published /IPRs/ Patents:-	
	Professional Memberships:-	
	Consultancy Activities:-	
	Awards:-	
	Grants fetched:-	
	Interaction with Professional Institutions:-	

	Name of Teaching Staff:- Aishwarya Sanjay Gunjal	
	Designation: - Assistant Professor	
		
	Department: - Computer Engineering	
	Date of Joining the Institution:- 14/09/2020	
	Qualifications with Class/Grade UG: - BE Computer (Distinction) PG: - ME Computer (Distinction)	
	Total Experience in Years: - 1 Teaching: - 0.4 Industry: - 0.6 Research:-	
	Papers Published :- National:- International:-5	
	Papers Presented in Conferences :- National: - 1 International:-1	
	PhD's Guide? Give field & University Field:- University:-	
	PhDs / Projects Guided PhDs:- Projects at Masters Level:-	
	Books Published /IPRs/ Patents:-	
	Professional Memberships:-	
	Consultancy Activities:-	
	Awards:-	
	Grants fetched:-	
	Interaction with Professional Institutions:-	

	Name of Teaching Staff:- Prof.Rahul Sanjay Bankar		
	Designation: - Head Of Department & Assistant Professor		
	Department: - Electrical Engineering Department		
	Date of Joining the Institution:- 21/06/2017		
	Qualifications with Class/Grade UG: - First Class Dist. PG: - First Class Dist.		
	Total Experience in Years: - 06 Teaching: - 05 Industry: - 01 Research:00		
	Papers Published :- 02	National:- 00	International:-01
	Papers Presented in Conferences :- 1	National: - 00	International:-01
	PhD's Guide? Give field & University	Field:-	University:-
	PhDs / Projects Guided	PhDs:-	Projects at Masters Level:-
	Books Published /IPRs/ Patents:- NIL		
	Professional Memberships:-ISTE,IET		
	Consultancy Activities:-NIL		
	Awards:- 3RD Prize in Project compl.		
	Grants fetched:-Nil		
	Interaction with Professional Institutions:-Nil		

	Name of Teaching Staff:- Prof. Utkarsha Ashok Khairnar	
	Designation: - Assistant Professor	
	Department: - - Electrical Engineering Department	
	Date of Joining the Institution:- 19/03/2019	
	Qualifications with Class/Grade	UG: - First Class
		PG: - First Class
	Total Experience in Years: - 05	Teaching: - 05
		Industry: - 0
		Research:-0
	Papers Published :- 03	National:- 02
		International:-01
	Papers Presented in Conferences :- 00	National: - 00
		International:-0
	PhD's Guide? Give field & University	Field:-
		University:-
	PhDs / Projects Guided	PhDs:-
		Projects at Masters Level:-
	Books Published /IPRs/ Patents:- Nil	
	Professional Memberships:- IET	
	Consultancy Activities:- Nil	
	Awards:-Nil	
	Grants fetched:-Nil	
	Interaction with Professional Institutions:-Nil	

	Name of Teaching Staff:- Prof. Rajendra Ramesh Purkar	
	Designation: - Assistant Professor	
	Department: - - Electrical Engineering Department	
	Date of Joining the Institution:- 17 June 2014	
	Qualifications with Class/Grade	UG: - First Class PG: - First Class
	Total Experience in Years: - Teaching: - 08 Industry: - 01 Research:-00	
	Papers Published :- 03	National:- 02 International:- 01
	Papers Presented in Conferences :- 02 National: - 02 International:-00	
	PhD's Guide? Give field & University	Field:- University:-
	PhDs / Projects Guided	PhDs:- Projects at Masters Level:-
	Books Published /IPRs/ Patents:- NIL	
	Professional Memberships:- IET,	
	Consultancy Activities:- NIL	
	Awards:- NIL	
	Grants fetched:- NIL	
	Interaction with Professional Institutions:- NIL	

	Name of Teaching Staff:- Prof. Shubham Narendra Patil	
	Designation: - Assistant Professor	
	Department: - - Electrical Engineering Department	
	Date of Joining the Institution:- 20/01/2020	
	Qualifications with Class/Grade UG: - First Class with Dist. PG: - First Class with Dist.	
	Total Experience in Years: - 01 Teaching: - 01 Industry: - 00 Research:-00	
	Papers Published :- 02 National:- 00 International:- 02	
	Papers Presented in Conferences :- 00 National: - 00 International:-00	
	PhD's Guide? Give field & University Field:- University:-	
	PhDs / Projects Guided PhDs:- Projects at Masters Level:-	
	Books Published /IPRs/ Patents:- Nil	
	Professional Memberships:- Nil	
	Consultancy Activities:-Nil	
	Awards:-Nil	
	Grants fetched:-Nil	
	Interaction with Professional Institutions:-Nil	

	Name of Teaching Staff:- Prof. Snehal Shivaji Uphade			
	Designation: - Assistant Professor			
	Department: - - Electrical Engineering Department			
	Date of Joining the Institution:- 17/08/2020			
	Qualifications with Class/Grade	UG: - First Class	PG: - First Class	
	Total Experience in Years: - 1	Teaching: - 1	Industry: - 00	Research:-0
	Papers Published :- 02	National:- 00	International:-02	
	Papers Presented in Conferences :- 00	National: -00	International:-00	
	PhD's Guide? Give field & University	Field:-	University:-	
	PhDs / Projects Guided	PhDs:-	Projects at Masters Level:-	
	Books Published /IPRs/ Patents:- Nil			
	Professional Memberships:- Nil			
	Consultancy Activities:-Nil			
	Awards:-Nil			
	Grants fetched:-Nil			
	Interaction with Professional Institutions:-Nil			

	Name of Teaching Staff:- Parag Shivaji Desale	
	Designation: - Assistant Professor	
	Department: - Mechanical Engineering	
	Date of Joining the Institution:- 11/12/2019	
	Qualifications with Class/Grade UG: - B.E. (Mechanical) with First Class PG: - M.E. (Heat Power) with First Class	
	Total Experience in Years: - Teaching: - 08 Industry: - 02 Research:-	
	Papers Published :-04 National:- 00 International:-04	
	Papers Presented in Conferences :- 00 National: - 00 International:-00	
	PhD's Guide? Give field & University Field:- NA University:- NA	
	PhDs / Projects Guided PhDs:- 00 Projects at Masters Level:- 00	
	Books Published /IPRs/ Patents:- 00	
	Professional Memberships:- Life Member, The Institution of Engineers (India)	
	Consultancy Activities:- Nil	
	Awards:- Nil	
	Grants fetched:- Nil	
	Interaction with Professional Institutions:- Nil	

	Name of Teaching Staff:- PRAVIN ARJUN RENUKE	
	Designation: - Asst.Professor in Mechanical Engineering	
	Department: - Mechanical Engineering	
	Date of Joining the Institution:- 01/01/2013	
	Qualifications with Class/Grade UG: - BE Mechanical - Distinction PG: - ME Mech.(Machine Design) - First Class	
	Total Experience in Years: - 12 Teaching: - 12 Industry: - Research:-	
	Papers Published :- 03 National:- 01 International:-03	
	Papers Presented in Conferences :- National: - International:-	
	PhD's Guide? Give field & University Field:- University:-	
	PhDs / Projects Guided PhDs:- Projects at Masters Level:-	
	Books Published /IPRs/ Patents:-	
	Professional Memberships:- LMISTE	
	Consultancy Activities:-	
	Awards:- Dissertation work selected for presentation for convocation.	
	Grants fetched:-	
	Interaction with Professional Institutions:-	

	Name of Teaching Staff:- SANTOSH YASHWANT KHALKAR	
	Designation: - Asst.Professor in Mechanical Engineering	
	Department: - Mechanical Engineering	
	Date of Joining the Institution:- 06/06/2015	
	Qualifications with Class/Grade UG: - BE Mechanical - First Class PG: - M.Tech.(Machine Design) - Distinction with Honors	
	Total Experience in Years: - 09 Teaching: - 09 Industry: - Research:-	
	Papers Published :- 7 National:- 0 International:-07	
	Papers Presented in Conferences :-1 National: -1 International:-	
	PhD's Guide? Give field & University Field:- University:-	
	PhDs / Projects Guided PhDs:- Projects at Masters Level:-	
	IPRs/ Patents:- 1. ONLINE SYSTEM AND METHOD FOR HYPERLOCAL SHOPPING AND COMMODITY DELIVERY	
	Professional Memberships:-	
	Consultancy Activities:-	
	Awards:- Dissertation work selected for presentation for convocation.	
	Grants fetched:-	
	Interaction with Professional Institutions:-	

	Name of Teaching Staff:- SWAPNIL VITTHALRAO LOKHANDE			
	Designation: - ASST. PROF.			
	Department: - MECHANICAL ENGG.			
	Date of Joining the Institution:- 11/08/2017			
	Qualifications with Class/Grade	UG: - DISTINCTION	PG: - FIRST CLASS	
	Total Experience in Years: -	Teaching: - 5.5	Industry: - 0	Research:- 0
	Papers Published :- 2	National:- 0	International:- 2	
	Papers Presented in Conferences :-	National: - 1	International:-0	
	PhD's Guide? Give field & University	Field:- NA	University:- NA	
	PhDs / Projects Guided NA	PhDs:- NA	Projects at Masters Level:- NA	
	Books Published /IPRs/ Patents:- 00			
	Professional Memberships:- 00			
	Consultancy Activities:-00			
	Awards:-00			
	Grants fetched:-00			
	Interaction with Professional Institutions:-00			

	Name of Teaching Staff:- Mr. Yogesh Sanjay Khairnar	
	Designation: - Assistant Professor	
	Department: - Mechanical Engineering	
	Date of Joining the Institution:- 17 December 2018	
	Qualifications with Class/Grade UG: - BE (Mechanical) Distinction PG: - ME (Design Engineering) Distinction	
	Total Experience in Years: - 03 Teaching: - 03 Industry: - 00 Research:-00	
	Papers Published :-00 National:- 00 International:-00	
	Papers Presented in Conferences :- 01 National: - 01 International:-00	
	PhD's Guide? Give field & University Field:- NA University:-NA	
	PhDs / Projects Guided PhDs:- NA Projects at Masters Level:-NA	
	Books Published /IPRs/ Patents:- 00	
	Professional Memberships:- 00	
	Consultancy Activities:-00	
	Awards:-00	
	Grants fetched:-00	
	Interaction with Professional Institutions:-00	

	Name of Teaching Staff:- DHANASHRI JAYANT GANORE	
	Designation: - Asst.Professor in Mechanical Engineering	
	Department: - Mechanical Engineering	
	Date of Joining the Institution:- 03/01/2019	
	Qualifications with Class/Grade UG: - BE Mechanical - First Class With Distinction PG: - M.E.(Heat Power) - Distinction	
	Total Experience in Years: - 07 Teaching: - 07 Industry: - Research:-	
	Papers Published :- 3 National:- 0 International:-03	
	Papers Presented in Conferences :-1 National: -1 International:-	
	PhD's Guide? Give field & University Field:- University:-	
	PhDs / Projects Guided PhDs:- Projects at Masters Level:-	
	Books Published /IPRs/ Patents:-	
	Professional Memberships:-	
	Consultancy Activities:-	
	Awards:- Dissertation work selected for presentation for convocation.	
	Grants fetched:-	
	Interaction with Professional Institutions:-	

	Name of Teaching Staff:- S.B. Jadhav	
	Designation: - Assistant Professor	
	Department: - Electrical Engineering	
	Date of Joining the Institution:- 04.July.2015	
	Qualifications with Class/Grade UG: - B.E. [First Division] PG: - M.E. [Appeared]	
	Total Experience in Years: - Teaching:- 1 Year Industry: - 1 Year Research:-	
	Papers Published :- National:-International:-	
	Papers Presented in Conferences :- National: - International:-	
	PhD's Guide? Give field & University Field:- University:-	
	PhDs / Projects Guided PhDs:-	
	Books Published /IPRs/ Patents:-	
	Professional Memberships:-	
	Consultancy Activities:-	
	Awards:-	
	Grants fetched:-	
	Interaction with Professional Institutions:-	

	Name of Teaching Staff:- Mrs.Shraddha Kiran Patil		
	Designation: - Librarian		
	Qualification: - SET (Maharashtra),BA.M.Lib.&Inf.Science		
	Date of Joining the Institution:- 04/02/2019		
	Qualifications with Class/Grade :- M.Lib.& Inf.Science	PG: - 1st class with Distinction	
	Total Experience in Years: - :12 Years		
	Papers Published :-	National:- 3	International:- 1
	Papers Presented in Conferences :-	National: -	International:-
	PhD's Guide? Give field & University	Field:-	University:-
	PhDs / Projects Guided	PhDs:-	Projects at Masters Level:-
	Books Published /IPRs/ Patents:-		
	Professional Memberships:- YES		
	Consultancy Activities:-		
	Awards:-		
	Grants fetched:-		
	Interaction with Professional Institutions:-		

	Name of Teaching Staff:- Khairnar Kamini Kadu	
	Designation: - Assistant Professor	
	Department: - Science	
	Date of Joining the Institution:- 08/03/2021	
	Qualifications with Class/Grade UG: - B.Sc. (First Class with Distinction) PG: - M.Sc. (First Class with Distinction)	
	Total Experience in Years: - 0 Teaching:- Industry: - Research:-	
	Papers Published :- 0 National:- International:-	
	Papers Presented in Conferences :- National: - International :-	
	PhD's Guide? Give field & University Field:- University:-	
	PhDs / Projects Guided PhDs:-	
	Books Published /IPRs/ Patents:-	
	Professional Memberships:-	
	Consultancy Activities:-	
	Awards:-	
	Grants fetched:-	
	Interaction with Professional Institutions:-	

	Name of Teaching Staff:- Mrs.Supriya Nilesh Thalur	
	Designation: - Assistant Professor	
	Department: - Electronics and Telecommunication Engineering.	
	Date of Joining the Institution:- 01/02/2021	
	Qualifications with Class/Grade UG: - First Class PG: - First Class with Distn.	
	Total Experience in Years: - Teaching: - 14 Years Industry: - 1.5 Years Research:-	
	Papers Published :- National:- 02 International:-06	
	Papers Presented in Conferences :- National: - 02 International:-03	
	PhD's Guide? Give field & University Field:- - University:--	
	PhDs / Projects Guided PhDs:- - Projects at Masters Level:- Speech coding	
	Books Published /IPRs/ Patents:- -	
	Professional Memberships:- ISTE	
	Consultancy Activities:--	
	Awards:- -	
	Grants fetched: --	
	Interaction with Professional Institutions:- -	

	Name of Teaching Staff:- Mr.Hemant Motiram Pawar	
	Designation: - Assistant Professor	
	Department: - Electrical Engineering.	
	Date of Joining the Institution:- 02/02/2021	
	Qualifications with Class/Grade UG: - First Class(6.25) PG: - Distinction(7.91)	
	Total Experience in Years: - Teaching: - - Industry: - - Research:-	
	Papers Published :- National:- 01 International:--	
	Papers Presented in Conferences :- National: - - International:- -	
	PhD's Guide? Give field & University Field:- - University:--	
	PhDs / Projects Guided PhDs:- - Projects at Masters Level:- Virtual Synchronous Machine	
	Books Published /IPRs/ Patents:- -	
	Professional Memberships:- -	
	Consultancy Activities:--	
	Awards:- -	
	Grants fetched: --	
	Interaction with Professional Institutions:- -	

	Name of Teaching Staff:- Kudal Gorakh Bhimraj	
	Designation: - Assistant Professor	
	Department: - Mechanical Engineering	
	Date of Joining the Institution:- 01/02/2021	
	Qualifications with Class/Grade UG: - B.E. Mechanical (First Class) PG: - M.E. (Heat Power) (First Class with Distinction)	
	Total Experience in Years: - 04 Teaching:- 04 Industry: Nil- Research:- Nil	
	Papers Published :- 03 National:- Nil International:- 03	
	Papers Presented in Conferences :- Nil National: - Nil International :- Nil	
	PhD's Guide? Give field & University Field:- University:-	
	PhDs / Projects Guided PhDs:-	
	Books Published /IPRs/ Patents:-	
	Professional Memberships:-	
	Consultancy Activities:-	
	Awards:-	
	Grants fetched:-	
	Interaction with Professional Institutions:-	

Sr. No.	Course	Sanctioned Intake	CAP	Against CAP	Institute Level	Total
1	Computer Engineering	60	24	10	00	34
2	Civil Engineering	30	10	10	00	20
3	Electrical Engineering	30	04	03	00	07
4	Mechanical Engineering	60	07	00	00	07
Total		180	45	23	00	68

Entrance test / admission criteria: - MH-CET / JEE

Cut off / last candidate admitted

CAY-2019-20 :- 48.33 Sonawane Akshay R.

CAY-1 :- 46.33 Gore Pranjal D.

CAY -2 :- 45.00 Dongarkar Runali D.

Fees in rupees	CAY :-2020-21	AY 2019-20	AY 2018-19
Adhoc tuition fee as approved by of Fee Regulating Authority ,for higher technical courses to be started in AY 2012-13	Open Category:Rs. 68000 OBC & EBC Category:- Rs.30769 Reserved category:- No Fee	Open Category:Rs. 68000 OBC & EBC Category:- Rs.30769 Reserved category:-No fees	Open Category:Rs. 60000 OBC & EBC Category:- Rs.27542 Reserved category:-No fees

Number of Fee Waivers offered CAY 2019-20 :-00 AY 2018-19 :- 00 AY 2017-18:- 06

Admission Calendar: - As per Direct Technical Education, Maharashtra Govt. notification

Particular	CAP round -I	CAP round -II	CAP round –III (by Counseling)	CAP round - IV	Institute level/Minority/Vacant seats
Submission online option form	07/01/2021 to 09/01/2021 Up	21/01/2021 to 23/01/2021 Up	_____	_____	
Display of provisional allotment	13/01/2021	25/01/2021	_____	_____	
Reporting	14/01/2021 to 20/01/2021 up to 3:00pm	26/01/2021 to 30/01/2021 Up to 5:00 pm	_____	_____	Till 05/02/2021
Cut of date	05/02/2021				
Starting of the academic section	21/01/2021				

PIO quota

No

College Building



Class Room



Chemistry Lab



Physics Lab



Mechanical Lab



Civil Lab



Electrical Lab



Electronics Lab



Computer Lab



Workshop



Library



Seminar Hall



17 Academic Sessions:- 2020-21

Examination system, Year / Sem:- Semester pattern

Period of declaration of results:	
I st Semester	Last week of January
II nd semester	Last week of June

18 Counseling / Mentoring: - One guardian teacher has been appointed to take care of 20 students for mentoring and counseling

Career Counseling:- started

Medical facilities:- Yes

Student Insurance:- No.

19 Students Activity Body:-Student council formed

Cultural activities:-Annual social gathering

Sports activities:-Annual sports

Literary activities:- To be initiated

Magazine / Newsletter:- Society publishes e-news letter

Technical activities / Tech Fest:- **Planned Technical Festival for 2021**

Industrial Visits / Tours:- **Conducted Industrial visits by each department in 2021**

Alumni activities:-N.A. (College is established in the academic year 2012-13)

20 Name of the Information Officer for RTI:- **Prof. Navnath V. Palde**

Designation:- Academic Affairs Officer

Phone number with STD code:- 02557-209090

FAX number with STD code:-02557-259091

Email:- navnath.palde@shremahavir.org